

Complementary Products

Specialty Windows

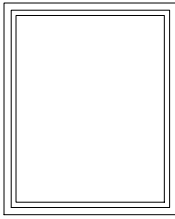

Rectangle

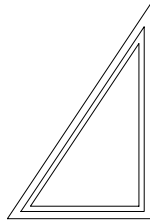

Right Triangle

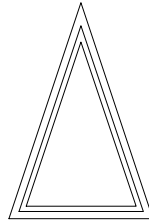

Isosceles Triangle

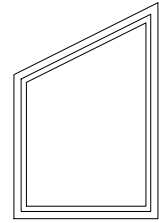

Trapezoid

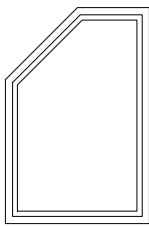

Angled Pentagon

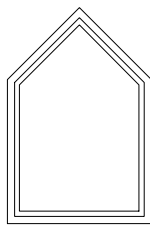

Peak Pentagon

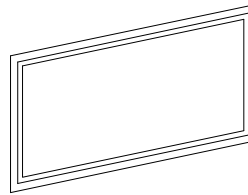

Parallelogram

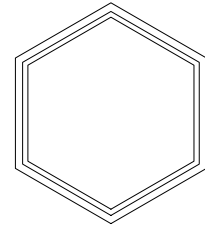

Equilateral Hexagon

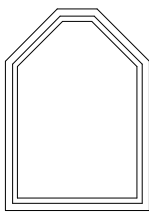

Double Clip Corner

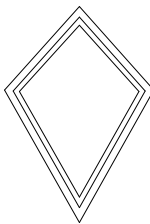

Diamond

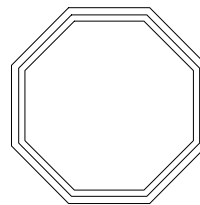

Octagon

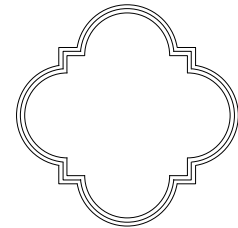

Quatrefoil

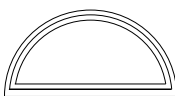

Circletop

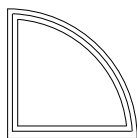

Quarter Round



Full Chord

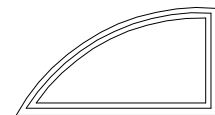

Partial Chord

Notes:

Details have been optimized for use in architectural software and do not match manufacturing specifications. Dimensions in parentheses are in millimeters.

See Pages 5-6 for Accessories

Date: 06/07/19
Scale: 3" (76) = 1' (305)

Complementary Products

Specialty Windows

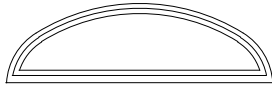

Elliptical

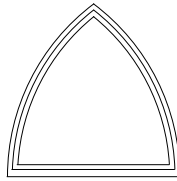

Gothic

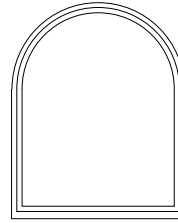

Springline

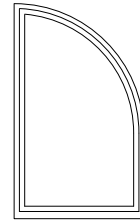

Springline Flanker

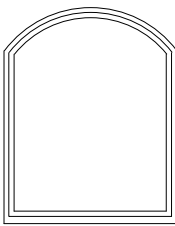

Archtop

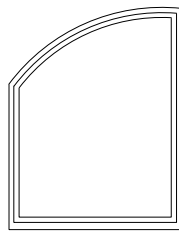

Unequal Leg Archtop

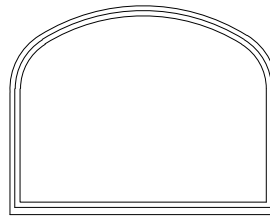

Extended Elliptical

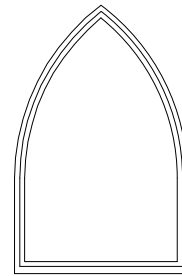

Extended Gothic

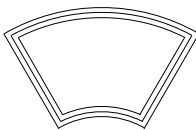

Partial Arch

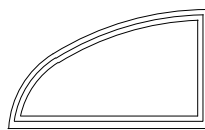

Partial Elliptical

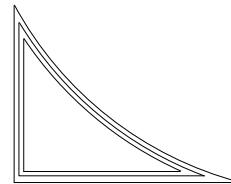

Reverse Partial Chord

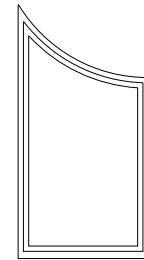

Extended Reverse Partial Chord

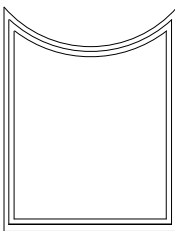

Extended Reverse Chord

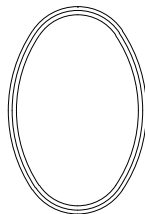

Oval

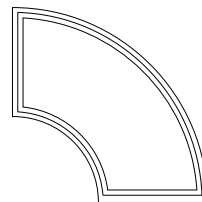

Quarter Arch

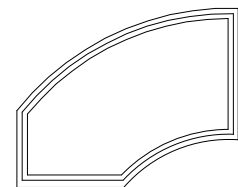

Partial Extended Arch

Notes:

Details have been optimized for use in architectural software and do not match manufacturing specifications. Dimensions in parentheses are in millimeters.

See Pages 5-6 for Accessories

Date: 06/07/19
Scale: 3" (76) = 1' (305)

Complementary Products

Specialty Windows

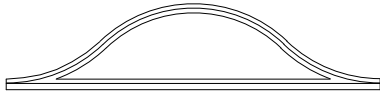

Eye brow

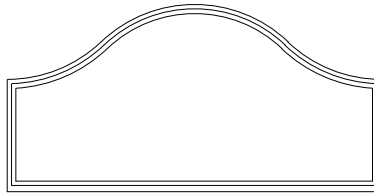

Extended Eye brow

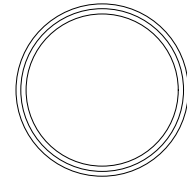

Circle

Notes:

Details have been optimized for use in architectural software and do not match manufacturing specifications.
Dimensions in parentheses are in millimeters.

[See Pages 5-6 for Accessories](#)

Date: 06/07/19
Scale: 3" (76) = 1' (305)

Complementary Products

Specialty Windows

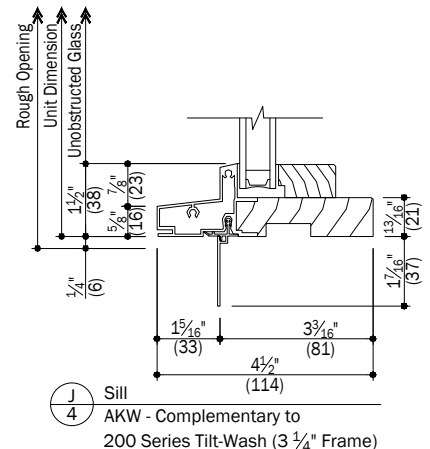
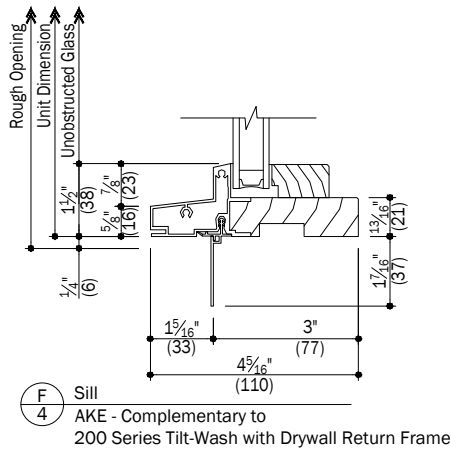
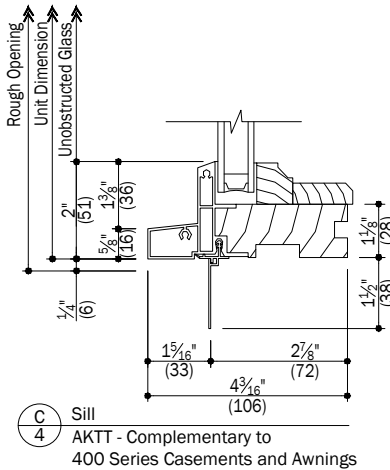
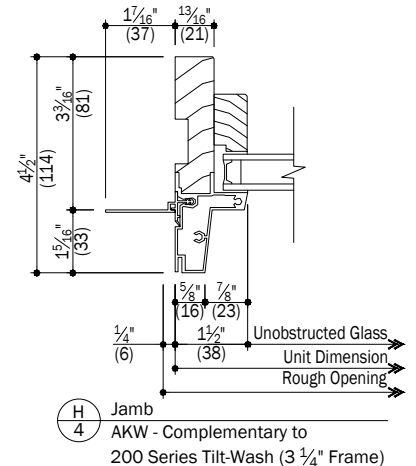
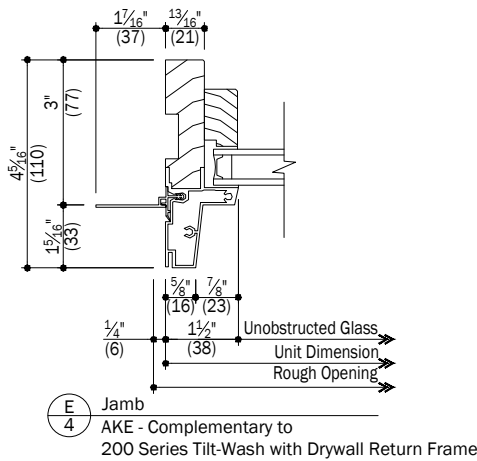
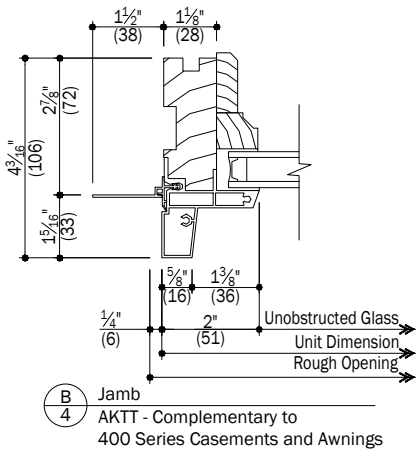
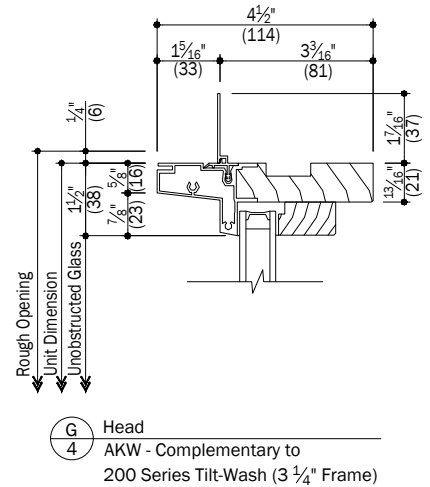
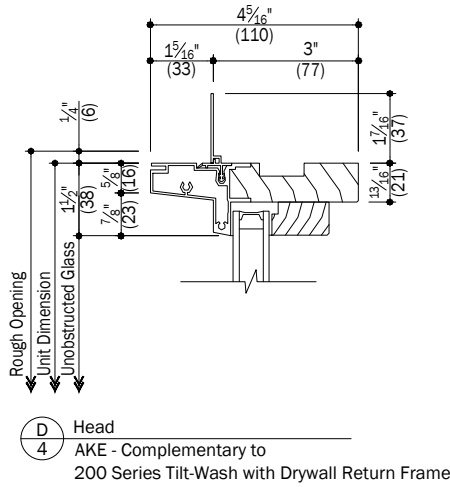
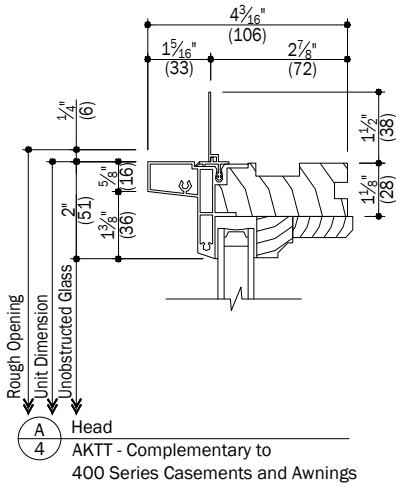

Notes:

Details have been optimized for use in architectural software and do not match manufacturing specifications. Dimensions in parentheses are in millimeters.

Date: 06/07/19
Scale: 3" (76) = 1' (305)

Complementary Products

Specialty Windows

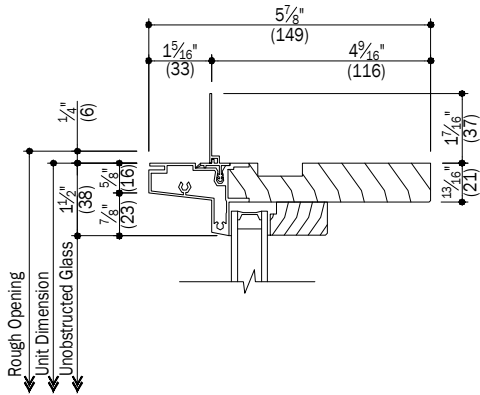

A Head
AKR - Complementary to
400 Series Tilt-Wash, Woodwright, FW Hinged, FW Gliding
200 Series Inswing Patio Door, Narroline, Permashield

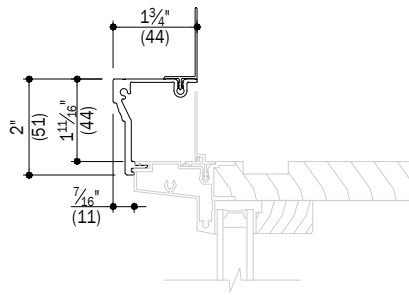

D 2" Aluminum Clad Brickmould

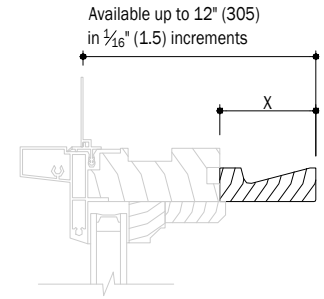

G Extension Jamb

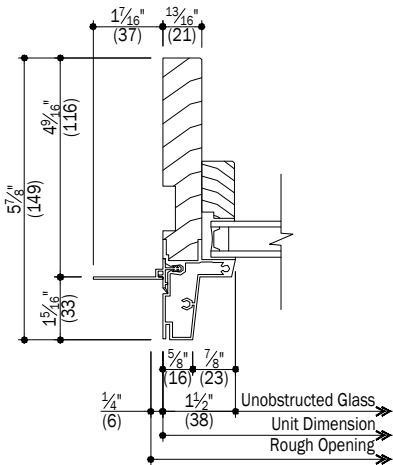

B Jamb
AKR - Complementary to
400 Series Tilt-Wash, Woodwright, FW Hinged, FW Gliding
200 Series Inswing Patio Door, Narroline, Permashield

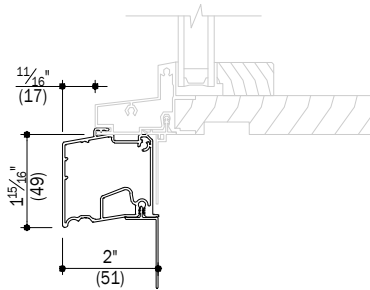

E Aluminum Clad Sillnose

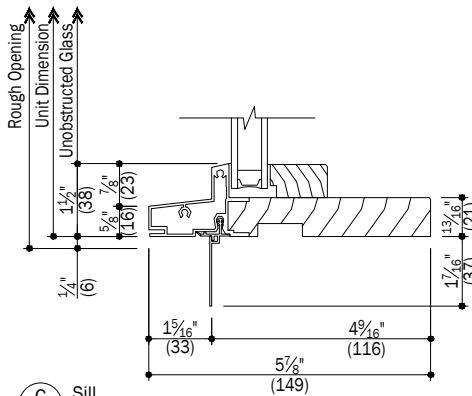

C Sill
AKR - Complementary to
400 Series Tilt-Wash, Woodwright, FW Hinged, FW Gliding
200 Series Inswing Patio Door, Narroline, Permashield

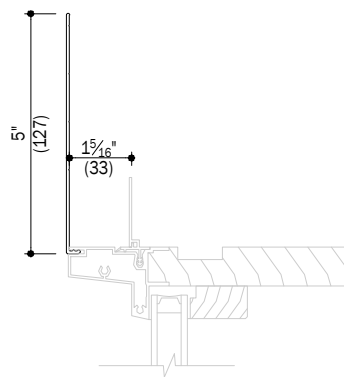

F 5" Aluminum Clad Frame Expander

Notes:

Details have been optimized for use in architectural software and do not match manufacturing specifications. Dimensions in parentheses are in millimeters.

Complementary Products

Specialty Windows

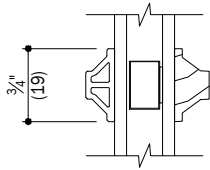

A
6 3/4" Full Divided Light

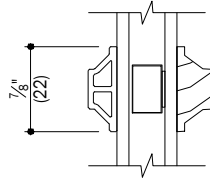

E
6 7/8" Full Divided Light

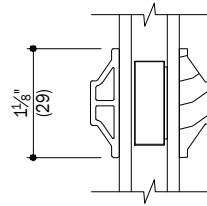

J
6 1 1/8" Full Divided Light

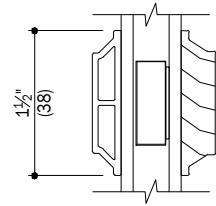

N
6 1 1/2" Full Divided Light

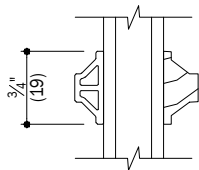

B
6 3/4" Simulated Divided Light
Removable interior is available

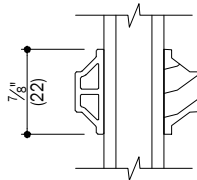

F
6 7/8" Simulated Divided Light
Removable interior is available

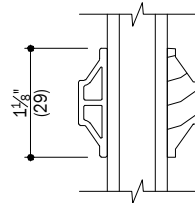

K
6 1 1/8" Simulated Divided Light
Removable interior is available

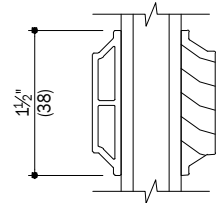

P
6 1 1/2" Simulated Divided Light

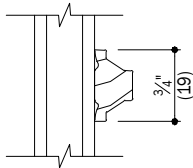

C
6 3/4" Removable Interior Grille

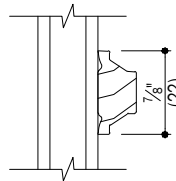

G
6 7/8" Removable Interior Grille

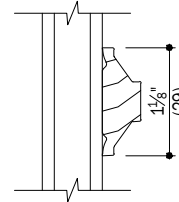

L
6 1 1/8" Removable Interior Grille

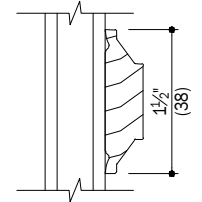

Q
6 1 1/2" Removable Interior Grille

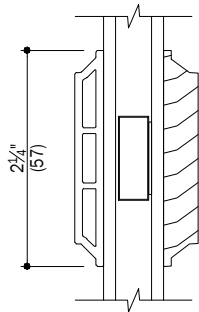

D
6 2 1/4" Full Divided Light
Simulated check rail

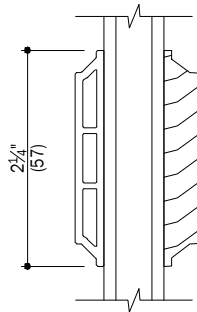

H
6 2 1/4" Simulated Divided Light
Simulated check rail

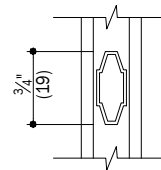

M
6 3/4" Finelight

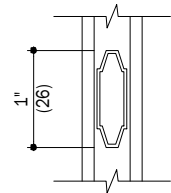

R
6 1" Finelight

Notes:

Details have been optimized for use in architectural software and do not match manufacturing specifications. Dimensions in parentheses are in millimeters.

Date: 06/07/19
Scale: 6" (76) = 1' (305)