

**What's in This Section**

**IMPORTANCE OF PROPER SELECTION:**  
 It is essential that you select the proper joining members for Andersen windows. Andersen strongly recommends consultation with an experienced structural engineer, contractor, architect or your local Andersen window supplier prior to the installation of any Andersen product. Installation of Andersen products is the sole responsibility of the architect, building owner, contractor, and/or consumer, and Andersen has no responsibility in this regard. For more information about joining materials, please see the Andersen Residential Product Guide, the Andersen Commercial Catalog, or the Andersen Architectural Detail File.

**Reinforced Mullion Joining Components ..... Page 3**

- Steel Reinforced Mullion ..... 3**
  - Casement, Awning, Specialty, and Circle Top™ Windows ..... 3
  - Tilt-Wash and Perma-Shield® Narroline® Windows ..... 5
- Aluminum Reinforced Mullion ..... 7**
  - Casement, Awning, Specialty, and Circle Top™ Windows ..... 7
- Exterior Extension Jambs ..... 9**
  - Extension Jamb Kit ..... 9



# Reinforced Mullion Joining Components (1990 to Present)

## Reinforced Mullion Joining Components

### Steel Reinforced Mullion

#### Casement, Awning, Specialty, and Circle Top™ Windows

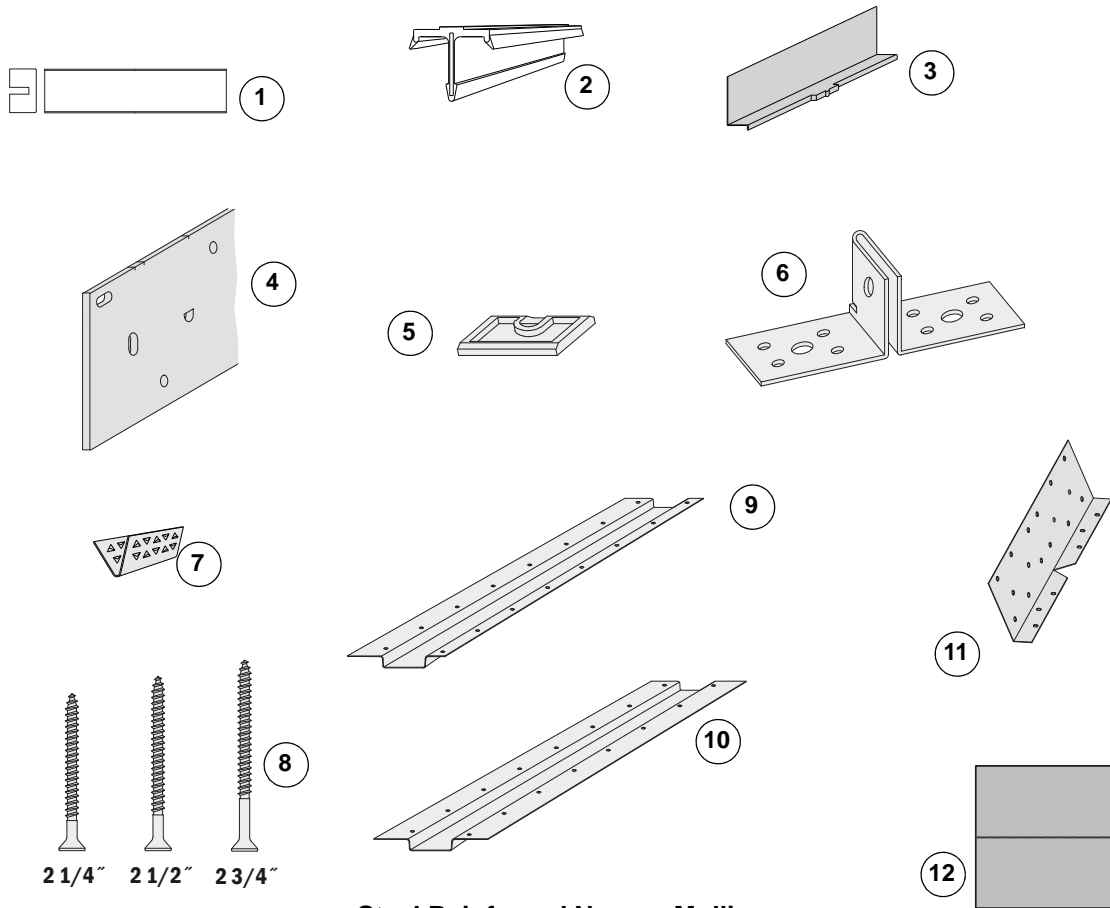

**Steel Reinforced Narrow Mullion  
for Casement, Awning, Specialty, and Circle Top™ Windows**

#### Inside Casing - Pine Ref. No. 1

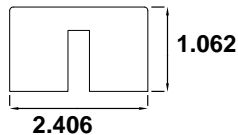

Length	2 3/8"	2 5/8"	2 15/16"
96 in	2340602	2340606	2340614
144 in	2340604	2340608	2340616

#### Inside Casing - White Prefinished Interior Ref. No. 1

Length	2 3/8"	2 5/8"	2 15/16"
96 in	2340617	2340619	2340621
144 in	2340618	2340620	2340622

## Steel Reinforced Mullion

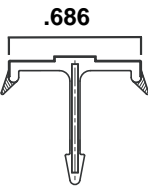
Exterior Trim Strip - Reinforced Mullion Ref. No. 2 <a href="#">page 3</a>								
	Length	White	Terratone	Sandtone	Forest Green	Canvas	Dark Bronze	Black
	96 in	2340504	2340508	2340512	2340528	9043184	9074013	9129253
	150 in	2340502	2340506	2340510	2340526	9043183	9074012	9129252
Exterior Flashing Ref. No. 3 <a href="#">page 3</a>								
	Length	White	Terratone	Sandtone	Forest Green	Canvas	Dark Bronze	Black
	6 in	1356008	1456008	0608402	0514129	9053178	9073185	9127237
Joining Strip - Steel Reinforced Mullion Ref. No. 4 <a href="#">page 3</a>								
							Unit Size	Order No.
							96 1/4 in	2340406
							114 in	2340408
							150 in	2340410

End Bracket Kit - Steel Reinforced Mullion / PSC/A/CT/FF Ref. No. 5 to 8 <a href="#">page 3</a>		
	<b>Includes:</b> Trim strip clip, screws, location block, and end bracket.	Order No.
		2340414
End Bracket - Steel Reinforced Mullion Ref. No. 6 <a href="#">page 3</a>		
		Order No.
		2340424
Clip - Trim Strip / Reinforced Mullion Ref. No. 7 <a href="#">page 3</a>		
		Order No.
		2340423
Gusset Plate Kit - Steel Reinforced Mullion / Doors / ET Ref. No. 11, 5, and 7 <a href="#">page 3</a>		
	<b>Includes:</b> Gussets, location block, and screws.	Order No.
		2340416
Gusset Plate - Metal / PS/FF Ref. No. 9 <a href="#">page 3</a>		
		Order No.
		2250208
Gusset Plate - Head and Sill Ref. No. 10 <a href="#">page 3</a>		
		Order No.
		1359508
Gusset Plate - Reinforced Mullion Ref. No. 11 <a href="#">page 3</a>		
		Order No.
		2340426
Flange Gasket - Mull Ref. No 12 <a href="#">page 3</a>		
	<b>Note:</b> Used over flange.	Order No.
		9122508
Gusset Plate - CTC/CTN/ET/DH		
		Order No.
		1359510

# Reinforced Mullion Joining Components (1990 to Present)

Reinforced Mullion Joining Components

## Steel Reinforced Mullion

### Tilt-Wash and Perma-Shield® Narroline® Windows

**Note:**

See [Joining Guide 0005184](#).

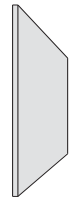
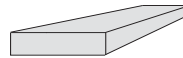
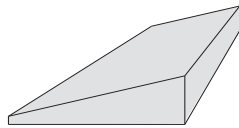
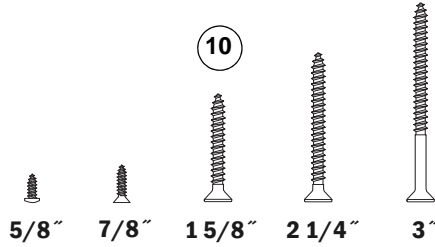
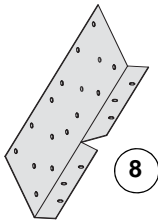
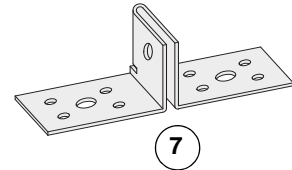
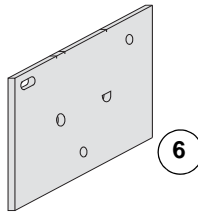
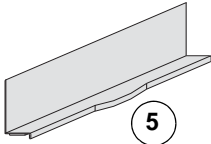
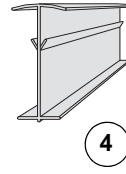
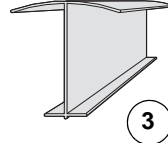
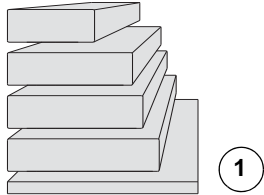

**Steel Reinforced Narrow Mullion  
for Double-Hung Windows**

### Inside Casing - Steel Reinforced Mullion Ref. No. 1

**Note:**

Inside wood casing must be modified. See installation instructions.

	Length	2 3/8"	2 5/8"	2 15/16"
	96 in	2340602	2340606	2340614
	144 in	2340604	2340608	2340616

## Steel Reinforced Mullion

Exterior Trim Strip - TW / Vertical Ref. No. 3 <a href="#">page 5</a>								
	Length	White	Terra-tone	Sand-tone	Forest Green	Canvas	Dark Bronze	Black
	150 in	1632926	2741726	1142426	0331797	9053177	9073178	9129320
Exterior Trim Strip - Transom/PSNL / Reinforced / Horizontal Ref. No. 4 <a href="#">page 5</a>								
	Length	White	Terra-tone	Sand-tone	Forest Green	Canvas	Dark Bronze	Black
	150 in	2340520	2340522	2340524	2340526	9087235	OBD	OBD

Joining Strip - Steel Reinforced Mullion Ref. No. 6 <a href="#">page 5</a>		
	Unit Size	Order No.
	96 1/4 in	2340406
	114 in	2340408
	150 in	2340410

End Bracket - Steel Ref. No. 7 <a href="#">page 5</a>	
	Order No.
	2340424
Gusset Plate Kit - PSNL / Steel Reinforced Mullion Ref. No. 8 <a href="#">page 5</a>	
	Order No.
	2340418

# Reinforced Mullion Joining Components (1990 to Present)

Reinforced Mullion Joining Components

## Aluminum Reinforced Mullion

### Casement, Awning, Specialty, and Circle Top™ Windows

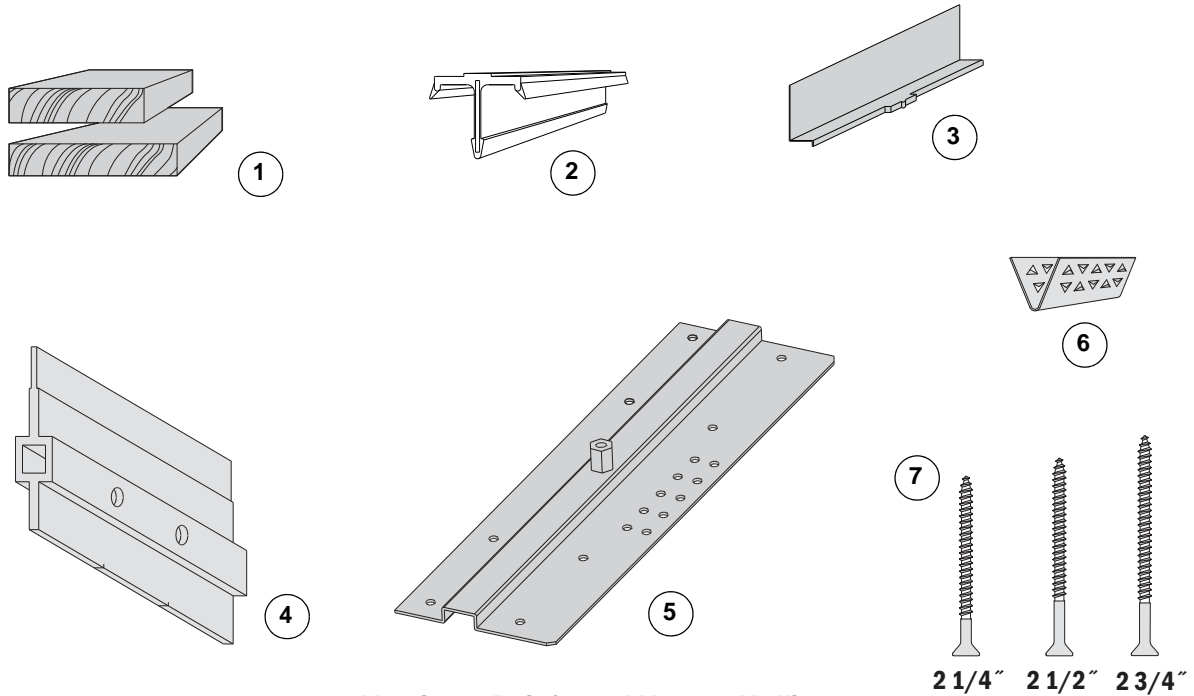

**Aluminum Reinforced Narrow Mullion  
for Casement, Awning, Specialty, and Circle Top™ Windows**

Inside Casing - Aluminum Reinforced Mullion Ref. No. 1				
	Length	2 3/8"	2 5/8"	2 7/8"
		Casement to Casement	Casement to Flexiframe	Flexiframe to Flexiframe
	96 in	1349022	1386812	1507622
	144 in	1349024	1386814	1507624

Exterior Trim Strip - Reinforced Mullion Ref. No. 2								
	Unit Size	White	Terra-tone	Sand-tone	Forest Green	Canvas	Dark Bronze	Black
	96 in	2340504	2340508	2340512	2340528	9043184	9074013	9129252
	150 in	2340502	2340506	2340510	2340526	9043183	9074012	9129253

Exterior Flashing Ref. No. 3								
	Length	White	Terra-tone	Sand-tone	Forest Green	Canvas	Dark Bronze	Black
	6 in	1356008	1456008	0608402	0514129	9033568	9073185	9127237

Joining Strip - Reinforced Mullion Ref. No. 4		
	Unit Size	Order No.
	72 3/32 in	2340402
	92 in	2340404

## Aluminum Reinforced Mullion

<b>End Plate Kit - Reinforced Mullion / PSC/A/CT/FF</b> Ref. No. 5, 6, and 7 <a href="#">page 7</a>	
<b>Includes:</b> End plates, trim strip clip, and screws	<b>Order No.</b> 2340412
<b>End Plate - Reinforced Mullion</b> Ref. No. 5 <a href="#">page 7</a>	
	<b>Order No.</b> 2340422
<b>Trim Clip - Reinforced Mullion</b> Ref. No. 6 <a href="#">page 7</a>	
	<b>Order No.</b> 2340423



# Reinforced Mullion Joining Components (1990 to Present)

*Reinforced Mullion Joining Components*

## Exterior Extension Jamb

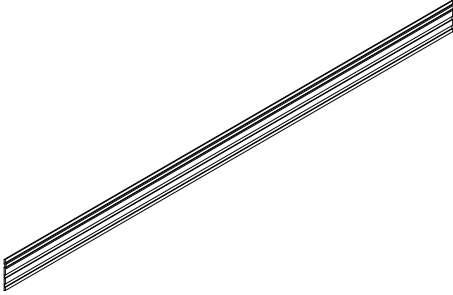
Extension Jamb Kit				
Extension Jamb Kit - Exterior				
	Note:	Unit No.	Dimension	Order No.
	<p>Kit has an aluminum joining strip. Use when joining a Frenchwood Hinged unit with an exterior extension jamb/double screen track applied to a Flexiframe transom unit.</p>	<b>FWH80</b>	79 1/2	2579701

## Notes

---