

What's in This Section

Tilt-Wash Insert Windows	Page 3
Parts Illustration	3
Unit Sizes	4
Custom Window Sizes	5
400 Series Product Label	5
Product History	6
Milestones	6
Complete Insert Windows	7
Complete Insert Windows	7
Sash	8
Sash - Upper or Lower	8
Weatherstrip	9
Sash Hardware / Lock Kits	10
Sash Hardware / Lifts	12
Sash Hardware / Opening Control Device Kit	14
Shim Kits/Components	14
Sash Components / Miscellaneous	15
Sash Balancers	16
Sash Balancers	16
Balancer Parts	17
Glass	18
Glass - Picture and Transom Units	18
Insect Screens	19
Insect Screen - Full	19
Insect Screen - Half	20
Insect Screen Parts	21
Grilles	22
Interior Grilles	22
Interior Grille Parts	22
Frames	23
Frame Assembly	23
Jamb Liners	24
Stops	25
Filler	26
Frame Parts	27
Joining Components	29

Narrow Joining Parts	29
Installation Materials	30
Installation Materials	30
Service Replacement	Page 33
Service Replacement Only	33
Service Replacement Only Parts	33
Complete Frame	33
Glazing Bead	34
Exterior Grilles - HDN	36

400 Series Tilt-Wash Insert Windows (2011 to Present)

Tilt-Wash Insert Windows

Parts Illustration

Parts Illustration

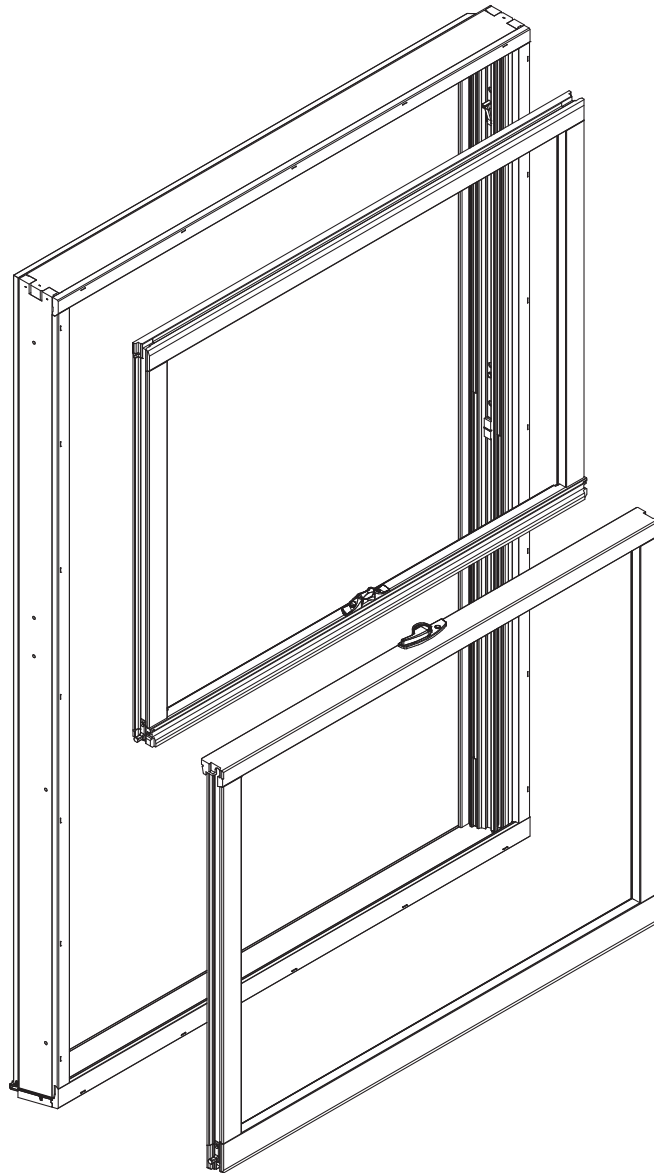

Manufactured 2011 to Present

Tilt-Wash Picture & Transom Insert Window Unit Parts

Unit Sizes

Unit Size Chart

Tilt-Wash Insert Window Size Ranges

Double-Hung - Equal Sash

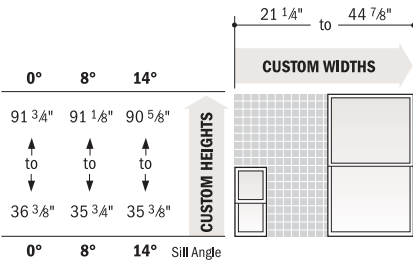

Double-Hung - Cottage & Reverse Cottage Sash

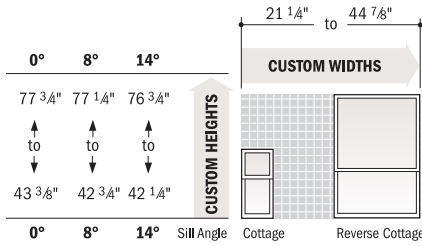

Picture

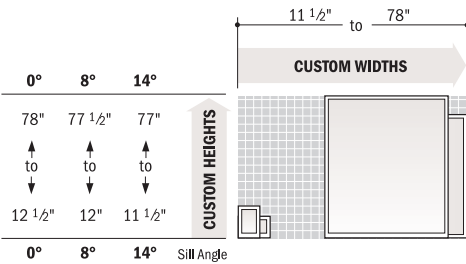

Transom

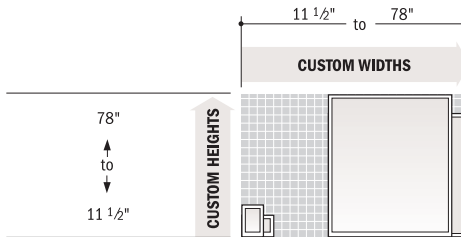

Available in 1/8" increments.

Height limits for double-hung and picture insert windows depend on new insert window sill angle.

For picture and transom insert windows, either height or width must be 68" or less and height plus width cannot be less than 28".

Tilt-Wash Picture & Transom Insert Window Unit Sizes

400 Series Tilt-Wash Insert Windows (2011 to Present)

Tilt-Wash Insert Windows

Unit Sizes

Custom Window Sizes

Note:

Tilt Wash Insert Windows are available in custom sizes in 1/8" increments between the smallest and the largest standard sizes. Most replacement parts for custom-sized windows are made to order and can be ordered with the Product ID found on the identification label and a description of the part needed. See [Service Guide 9051877](#). See [Size Chart](#).

400 Series Product Label

Note:

Every Tilt Wash Insert Window will have an identification label or glass etching containing a unique Product ID. The label on a double-hung insert is located in the upper left corner of the upper sash head jamb track. The label on a picture or transom unit is located under the side stop in the lower right-hand corner or etched into the glass. See [Service Guide 9051877](#). The Product ID may be up to 14 digits long (excluding hyphens), depending on the age of the unit. Replacement parts will also get their own unique Product ID. When ordering replacement parts, providing the Product ID ensures that replacement parts match the specifications.

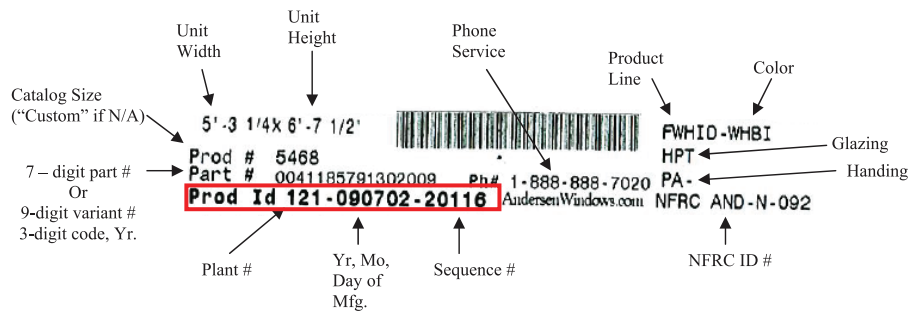

Product History

Milestones

2011 Tilt-Wash Insert Windows introduced.

Complete Insert Windows

Complete Insert Windows

Complete Insert Window

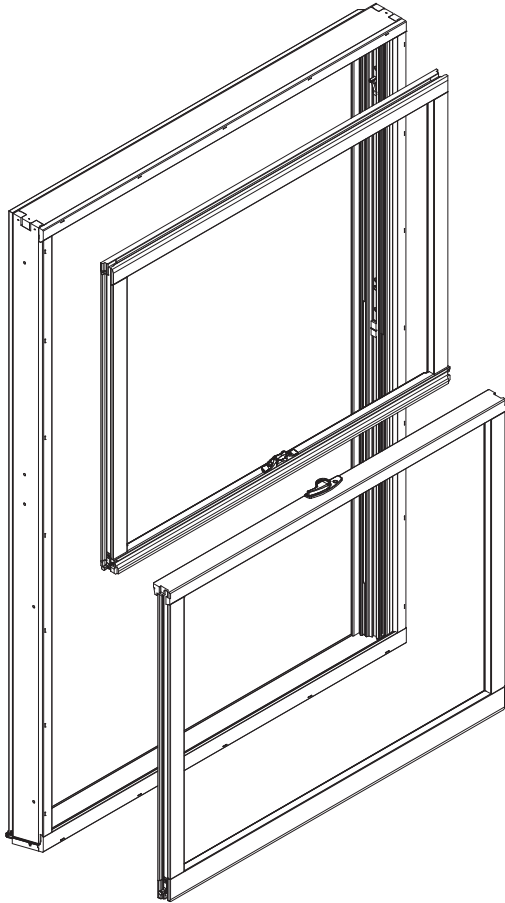
**Note:**

All Tilt-Wash insert windows are made to order.

Perma-Shield® Narroline® and Primed Narroline® windows one-step and two-step sills are at a 14° angle.

Exterior color options:

White, Terratone®, Sandtone, Forest Green, Canvas, Dark Bronze, Black

Interior finish options:

Pine or Prefinished White

Glass options:

[High-Performance Low-E4®](#)

High-Performance Low-E4® SmartSun™

High-Performance Low-E4® Sun

[High Performance Low-E4® Tempered](#)

High-Performance Low-E4® SmartSun™ Tempered

High-Performance Low-E4® Sun Tempered.

Other glass options are available. Contact your Andersen supplier.

Factory applied grille options:

Finelight™ grilles-between-the-glass

High-definition grilles - Full divided light with spacer

Simulated divided light without spacer

Exterior grilles

To order, state:

1. **Description of Part (Complete Insert)**
2. **Quantity**
3. **Product ID (from product label, see [page 5](#))**
4. **Options Desired**

Sash

Sash - Upper or Lower

Sash - Upper or Lower

Note:

See latest [Product Details](#). See [Service Guide 0005177](#).

Upper Sash

Lower Sash

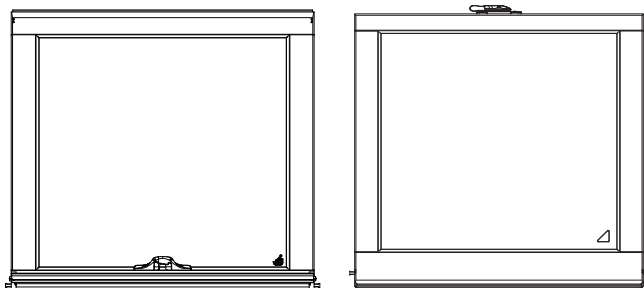

Glass Logo

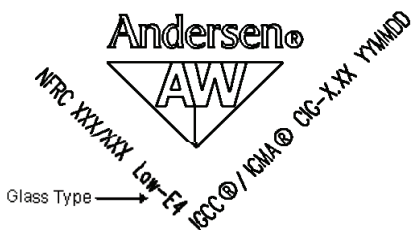

Glass Type →

Tempered Logo



Note:

Replacement sash is made to order. Sash does not include hardware.

Exterior color options:

White	Terratone®	Sandtone
Forest Green	Canvas	Dark Bronze
Black		

Interior finish options:

Pine	Prefinished White	

Glass options (See Logo example):

High-Performance Low-E4®	High-Performance Low-E4® SmartSun™	High-Performance Low-E4® Sun
High Performance Low-E4® Tempered	High-Performance Low-E4® SmartSun™ Tempered	High-Performance Low-E4® Sun Tempered

Glass pane thickness:

Glass Date:	Pane Thickness:
2016 - Present	2.2
2011 - 2015	3.0

Factory applied grille options:

- Finelight™ grilles-between-the-glass
- High-definition grilles - Full divided light with spacer
- Simulated divided light without spacer
- Exterior grilles



To order, state:

1. Description of Part (upper or lower sash)
2. Quantity
3. Product ID (from product label, see [page 5](#))
4. Glass Pane Thickness (If not available from ID)
5. Options Desired (if different than original product)

400 Series Tilt-Wash Insert Windows (2011 to Present)

Tilt-Wash Insert Windows

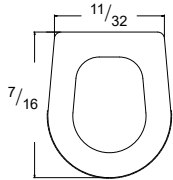
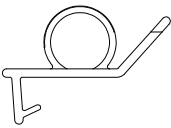
Sash

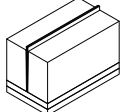
Weatherstrip			
Note: See Weatherstrip Replacement Video .			
Weatherstrip - Top and Bottom Rail (5/2020 - Present)			
	Note: Cut to size if necessary. Replaces previous vintages of weatherstrip.	Length	Order No.
		46	9181576
Weatherstrip - Upper Check Rail			
	Note: Cut to size if necessary.	Order No.	
		1631842	
Weatherstrip - Side/Stile			
	Note: Cut to size if necessary.	Length	Order No.
		36 ¹⁵ / ₁₆	1631547
		71 ¹⁵ / ₁₆	1631514
Weatherstrip - Check Rail Dust Pad			
	Note: Cut to size if necessary.	Order No.	
		1623072	

Sash

Sash Hardware / Lock Kits

Note:
See [Replacement Video](#).

Lock Kit - Flush Mount / Composite

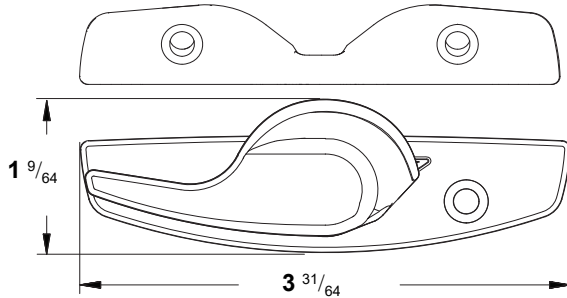

Kit includes:

- (1) Lock
- (1) Keeper
- (4) Screws.

Note:
Used as standard through 2012.

Finish	Order No.
Stone	1630020
White	1630029

Lock Kit - Flush Mount / Estate

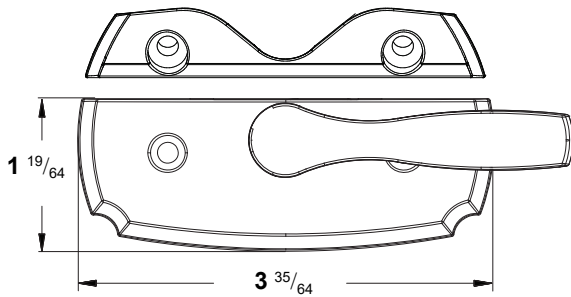

Kit Includes:

- (1) Lock
 - (1) Keeper
 - (4) Screws
- [Accessory Guide 0005256](#).

See [page 11](#) for individual screws. Distressed Nickel uses Satin Nickel finish, Distressed Bronze uses Black finish.

Note:
Can be used as an upgrade to standard hardware.

Finish	Order No.
Antique Brass	1600695
Bright Brass	1669321
Chrome	1669323
Brushed Chrome	1600406
Satin Nickel	1642924
Oil Rubbed Bronze	1642923
Distressed Bronze	1600407
Distressed Nickel	1600401

400 Series Tilt-Wash Insert Windows (2011 to Present)

Tilt-Wash Insert Windows

Sash

Lock Kit - Traditional

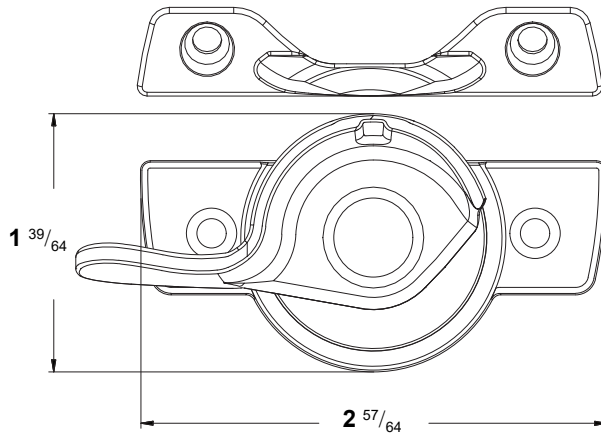

Kit includes:

- (1) Lock (metal)
- (1) Keeper (metal)
- (4) Screws

Note:

Used as standard from 2013 to present. Can be used as an upgrade on sash with flush mount hardware.

Finish	Order No.
Stone	9069432
White	9069433
Black	9069434
Gold Dust	9069435

Screw - Lock and Keeper

Description	Color	Order No.
6-10 x 3/4" PLS Z PH SP oval STL ZD	Stone	3620225
	White	3620226
	Gold Dust	9004465
	Black	9004466
	Bright Brass	9004467
	Satin Nickel	9004468
	Oil-Rubbed Bronze	9004469
	Antique Brass	9004470
	Brushed Chrome	9004471
	Polished Chrome	9004472

Sash

Sash Hardware / Lifts

Note:

See [Accessory Guide 9166501](#). See [Accessory Guide 9159962](#). See [Installation Video](#).
 Bar lift and hand lift quantity of one, finger lift quantity of two.

Lift w/Screws - Classic

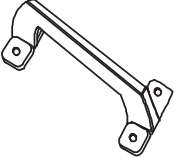
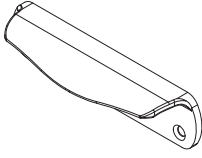
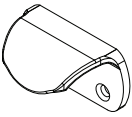
			
	Sash Lift	Hand Lift	Finger Lift (Pair)
Color	Order No.	Order No.	Order No.
Stone	1630027	1643001	1643003
White	1630025	1643002	1643004

Lift w/Screws - Traditional (8/2017 - Present)

Note:

For units manufactured from 2011 to July 2017 see Traditional style lifts in [A-Series Double-Hung](#) section.

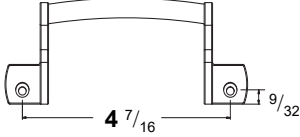
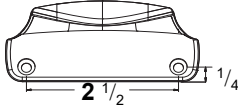
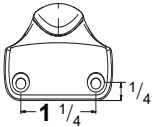
			
	Bar Lift w/Screws	Hand Lift w/Screws	Finger Lift w/Screws
Color	Order No.	Order No.	Order No.
White	9159470	9159482	9159494
Stone	9159471	9159483	9159495
Gold Dust	9159468	9159480	9159492
Black	9159469	9159481	9159493
Bright Brass	9159461	9159473	9159485
Satin Nickel	9159465	9159476	9159489
Oil-Rubbed Bronze	9159463	9159475	9159487
Antique Brass	9159460	9159472	9159484
Brushed Chrome	9159462	9159474	9159486
Polished Chrome	9159464	9159477	9159488
Distressed Bronze	9159466	9159478	9159490
Distressed Nickel	9159467	9159479	9159491

400 Series Tilt-Wash Insert Windows (2011 to Present)

Tilt-Wash Insert Windows

Sash

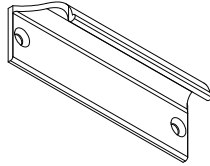
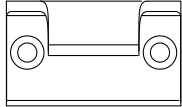
Lift w/Screws - Estate		
		
	Hand Lift	Finger Lift (Pair)
Color	Order No.	Order No.
Antique Brass	1600694	1600693
Bright Brass	1643043	1643040
Chrome	N/A	N/A
Brushed Chrome	N/A	N/A
Satin Nickel	1642922	1642920
Oil Rubbed Bronze	1642921	1642919
Distressed Bronze	1642932	1642931
Distressed Nickel	1600405	1600403

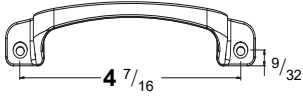
Lift w/Screws - Contemporary (8/2017 - Present)	
	
	Bar Lift w/Screws
Color	Order No.
White	9160290
Stone	9160291
Gold Dust	9160288
Black	9160289
Bright Brass	9160281
Satin Nickel	9160285
Oil-Rubbed Bronze	9160283
Antique Brass	9160280
Brushed Chrome	9160282
Polished Chrome	9160284
Distressed Bronze	9160286
Distressed Nickel	9160287

Sash

Sash Hardware / Opening Control Device Kit

Opening Control Device Kit

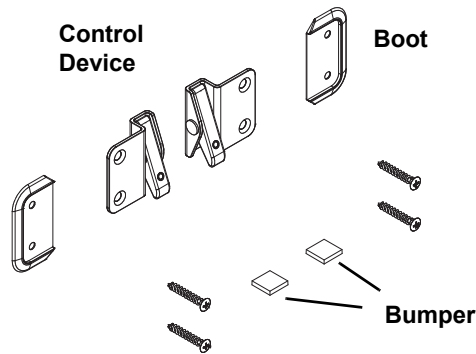

Kit includes: Two opening control devices, two boots, screws, bumpers and Accessory Guide 9021977 .	Finish	Order No.
	Stone	9021976
	White	9021975

Opening Control Device / Factory Installed

Note:
See Dealer Bulletin 56-17 for more information.

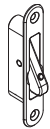

	Finish	Order No.
	Stone	9152278
	White	9152277
	Black	9152281

Screw - Opening Control Device / Factory Installed

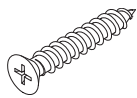

Description:
6-18 x 7/8" PHFH TYP A Tapping

	Color	Order No.
	Stone	9152280
	White	9152279
	Black	9172547

Shim Kits/Components

Shim Kits

		Classic	Estate	Traditional	
Color	Keeper	Lock	Keeper	Lock	Kit (Lock & Keeper)
White	0100083	1646144	1646143	9173745	9069437
Stone	0100085	1152528	1152527	9173746	9069436
Black	-	-	-	-	9069438
Gold Dust	-	-	-	-	9069439

400 Series Tilt-Wash Insert Windows (2011 to Present)

Tilt-Wash Insert Windows

Sash

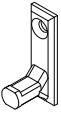
Sash Components / Miscellaneous		
Pivot - Sash		
		Order No.
		1643018
Screw - Sash Pivot		
	Description	Order No.
	6-10V 3/4" PLS Z PH S oval 410 SS brite wax	3621996

Sash Balancers

Sash Balancers

Sash Balancers

Note:

The balancer number is imprinted onto the side of each balancer. The first two characters are the case length, and the last character is the load rating code letter. Refer to the charts below to find the proper order number.

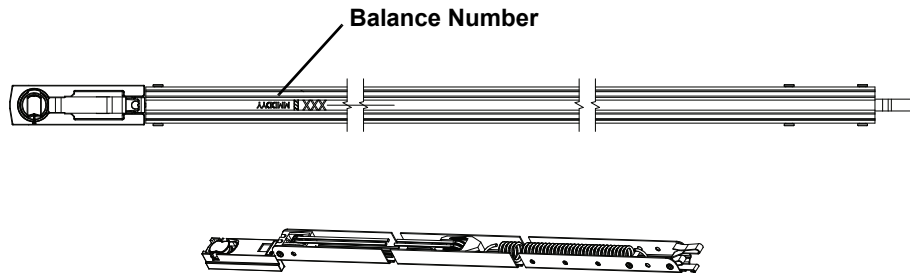

Tilt-Wash Insert Sash Balancer

Sash Balancers

Balancer No.	Order No.	Balancer No.	Order No.	Balancer No.	Order No.	Balancer No.	Order No.
14A	9043715	18C	9043735	22E	9043755	26G	9043775
14B	9043716	18D	9043736	22F	9043756	26H	9043776
14C	9043717	18E	9043737	22G	9043757	26I	9043777
14D	9043718	18F	9043738	22H	9043758	28A	9043778
14E	9043719	18G	9043739	22I	9043759	28B	9043779
14F	9043720	18H	9043740	24A	9043760	28C	9043780
14G	9043721	18I	9043741	24B	9043761	28D	9043781
14H	9043722	20A	9043742	24C	9043762	28E	9043782
14I	9043723	20B	9043743	24D	9043763	28F	9043783
16A	9043724	20C	9043744	24E	9043764	28G	9043784
16B	9043725	20D	9043745	24F	9043765	28H	9043785
16C	9043726	20E	9043746	24G	9043766	28I	9043786
16D	9043727	20F	9043747	24H	9043767	30A	9043787
16E	9043728	20G	9043748	24I	9043768	30B	9043788
16F	9043729	20H	9043749	26A	9043769	30C	9043789
16G	9043730	20I	9043750	26B	9043770	30D	9043790
16H	9043731	22A	9043751	26C	9043771	30E	9043791
16I	9043732	22B	9043752	26D	9043772	30F	9043792
18A	9043733	22C	9043753	26E	9043773	30G	9043793
18B	9043734	22D	9043754	26F	9043774	30H	9043794

400 Series Tilt-Wash Insert Windows (2011 to Present)

Tilt-Wash Insert Windows

Sash Balancers

Sash Balancers continued							
Balancer No.	Order No.	Balancer No.	Order No.	Balancer No.	Order No.	Balancer No.	Order No.
30I	9043795	34E	9043809	38A	9043823	40F	9043837
32A	9043796	34F	9043810	38B	9043824	40G	9043838
32B	9043797	34G	9043811	38C	9043825	40H	9043839
32C	9043798	34H	9043812	38D	9043826	40I	9043840
32D	9043799	34I	9043813	38E	9043827	42A	9043841
32E	9043800	36A	9043814	38F	9043828	42B	9043842
32F	9043801	36B	9043815	38G	9043829	42C	9043843
32G	9043802	36C	9043816	38H	9043830	42D	9043844
32H	9043803	36D	9043817	38I	9043831	42E	9043845
32I	9043804	36E	9043818	40A	9043832	42F	9043846
34A	9043805	36F	9043819	40B	9043833	42G	9043847
34B	9043806	36G	9043820	40C	9043834	42H	9043848
34C	9043807	36H	9043821	40D	9043835	42I	9043849
34D	9043808	36I	9043822	40E	9043836		

Balancer Parts

Balancer Clip

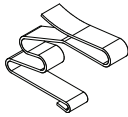

Order No.

9045101

Glass

Glass - Picture and Transom Units

Glass - Picture and Transom Units

Glass Logo

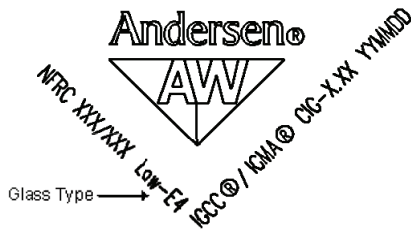

Tempered Logo

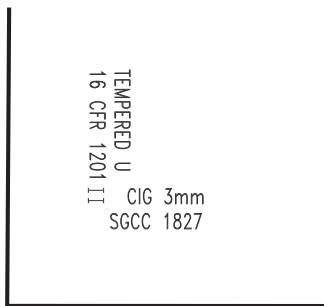

Glass options (See Logo example):

High-Performance Low-E4®	High-Performance Low-E4® SmartSun™	High-Performance Low-E4® Sun
High Performance Low-E4® Tempered	High-Performance Low-E4® SmartSun™ Tempered	High-Performance Low-E4® Sun Tempered

Glass pane thickness:

Glass Date:	Pane Thickness:
2016 - Present	2.2
2011 - 2015	3.0

Factory applied grille options:

- Finelight™ grilles-between-the-glass
- High-definition grilles - Full divided light with spacer
- Simulated divided light without spacer
- Exterior grilles

To order, state:

1. Description of Part (Picture or Transom window glass)
2. Quantity
3. Product ID (from product label, see [page 5](#))
4. Glass Pane Thickness (If not available from ID)
5. Options Desired (if different than original product)

400 Series Tilt-Wash Insert Windows (2011 to Present)

Tilt-Wash Insert Windows

Insect Screens

Insect Screen - Full

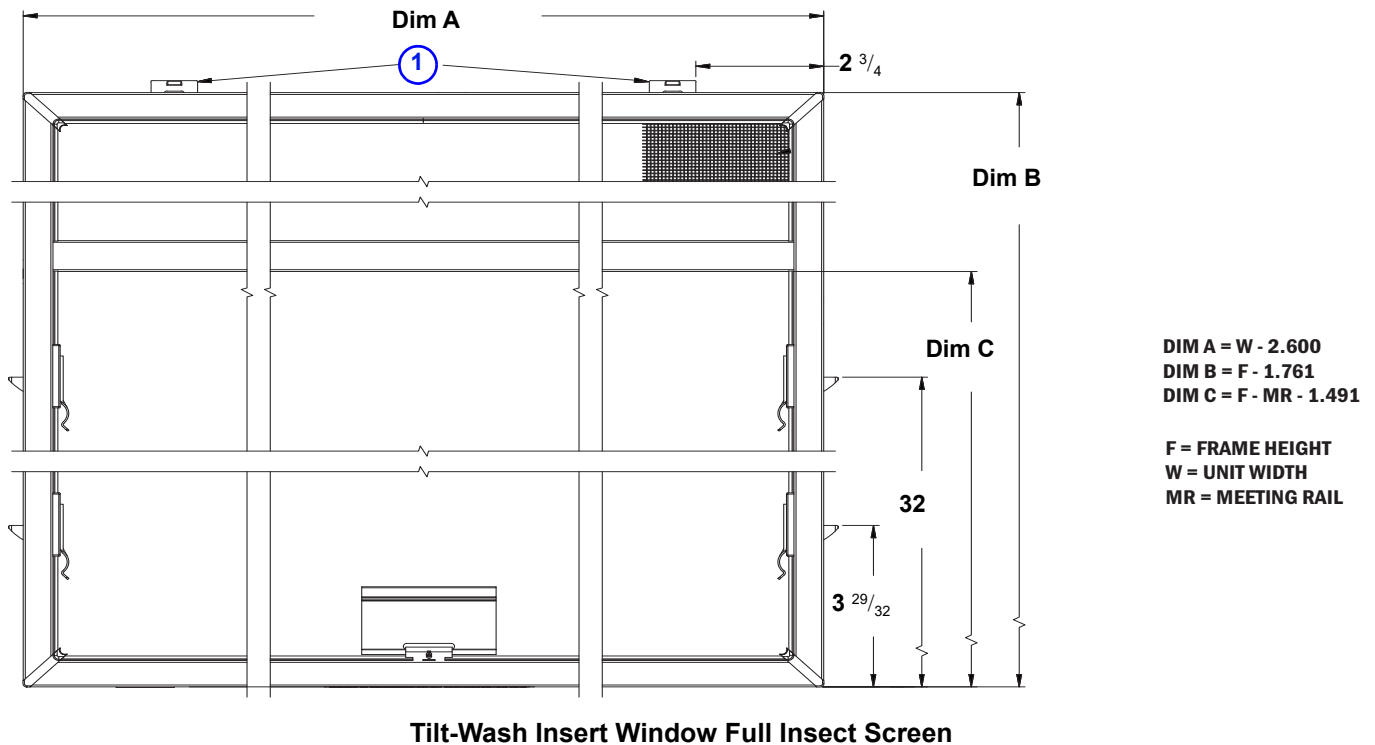

Insect Screen - Full / TruScene®

Note:

Full window insect screens with TruScene® screens are made to order. Second set of latches required only when screen height is greater than 69.844", unless center bar location dimension is less than 34.550".

To order, state:

1. Description of Part (full insect screen with TruScene® screen)
2. Quantity
3. Product ID (from product label, see [page 5](#))

Insect Screen - Full / Standard

Note:

Full window insect screens with standard screens are made to order. Second set of latches required only when screen height is greater than 69.844", unless center bar location dimension is less than 34.550".

To order, state:

1. Description of Part (full insect screen with standard screen)
2. Quantity
3. Product ID (from product label, see [page 5](#))

Insect Screens

Insect Screen - Half

Note:

See [Accessory Guide 0005475](#).

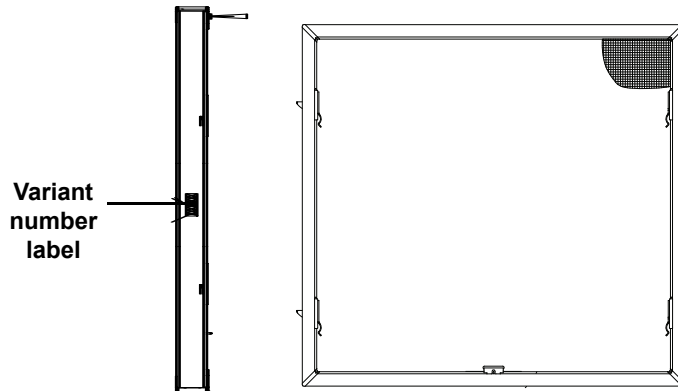

Tilt-Wash Insert Window Half Insect Screen

Insect Screen - Half / TruScene®

Note:

TruScene® half insect screen replacements are made to order.

To order, state:

1. Description of Part (TruScene® half screen)
2. Quantity
3. Product ID (from product label, see [page 5](#))

Insect Screen - Half / Standard

Note:

Standard half insect screen replacements are made to order.





To order, state:

1. Description of Part (Standard half screen)
2. Quantity
3. Product ID (from product label, see [page 5](#))

400 Series Tilt-Wash Insert Windows (2011 to Present)

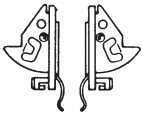
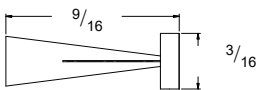
Tilt-Wash Insert Windows

Insect Screens

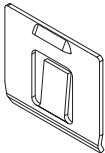
Insect Screen Parts												
Screen Lock with Housing (Pair)												
		<table border="1"> <thead> <tr> <th>Color</th> <th>Order No.</th> </tr> </thead> <tbody> <tr> <td>White</td> <td>1693417</td> </tr> <tr> <td>Terratone®</td> <td>2791264</td> </tr> <tr> <td>Sandtone</td> <td>1191313</td> </tr> <tr> <td>Forest Green</td> <td>0381364</td> </tr> </tbody> </table>	Color	Order No.	White	1693417	Terratone®	2791264	Sandtone	1191313	Forest Green	0381364
	Color	Order No.										
	White	1693417										
	Terratone®	2791264										
Sandtone	1191313											
Forest Green	0381364											
Bug Seal												
		<table border="1"> <thead> <tr> <th>Length</th> <th>Order No.</th> </tr> </thead> <tbody> <tr> <td>4'</td> <td>9043127</td> </tr> </tbody> </table>	Length	Order No.	4'	9043127						
	Length	Order No.										
4'	9043127											
Finger Pull - Insect Screen / Full												
		<table border="1"> <thead> <tr> <th>Order No.</th> </tr> </thead> <tbody> <tr> <td>8121701</td> </tr> </tbody> </table>	Order No.	8121701								
Order No.												
8121701												
Screen Label with Clip												
		<table border="1"> <thead> <tr> <th>Order No.</th> </tr> </thead> <tbody> <tr> <td>1631110</td> </tr> </tbody> </table>	Order No.	1631110								
Order No.												
1631110												
Retractable Screen Pull (7/2023 - Present)												
		<table border="1"> <thead> <tr> <th>Order No.</th> </tr> </thead> <tbody> <tr> <td>9199627</td> </tr> </tbody> </table>	Order No.	9199627								
Order No.												
9199627												
Screen Clip - Top Rail Ref. No. 1 page 19												
	<p>Note: Use with full screen.</p>	<table border="1"> <thead> <tr> <th>Order No.</th> </tr> </thead> <tbody> <tr> <td>9069417</td> </tr> </tbody> </table>	Order No.	9069417								
Order No.												
9069417												

Grilles

Interior Grilles

Interior Grilles - Removable

Note:

See [Accessory Guide 9033637](#).

	<p>Note: Removable interior grilles are made to order. Grilles include fasteners.</p> <p><i>To order, state:</i></p> <ol style="list-style-type: none"> 1. Description of Part (removable interior grilles) 2. Quantity 3. Product ID (from product label, see page 5)
--	---

Interior/Exterior Grilles - High-Definition

Note:

Replacement Finelight™ grilles, high-definition interior and exterior grilles are available as part of a replacement sash only. To order, see upper and lower sash, [page 8](#).

Interior Grille Parts

Fastener - Grille Plunger

		<p>Order No. 1344401</p>
--	--	-------------------------------------

Installation Guide/Aid

		<p>Order No. 9033637</p>
--	--	-------------------------------------

Frame Assembly

Note:

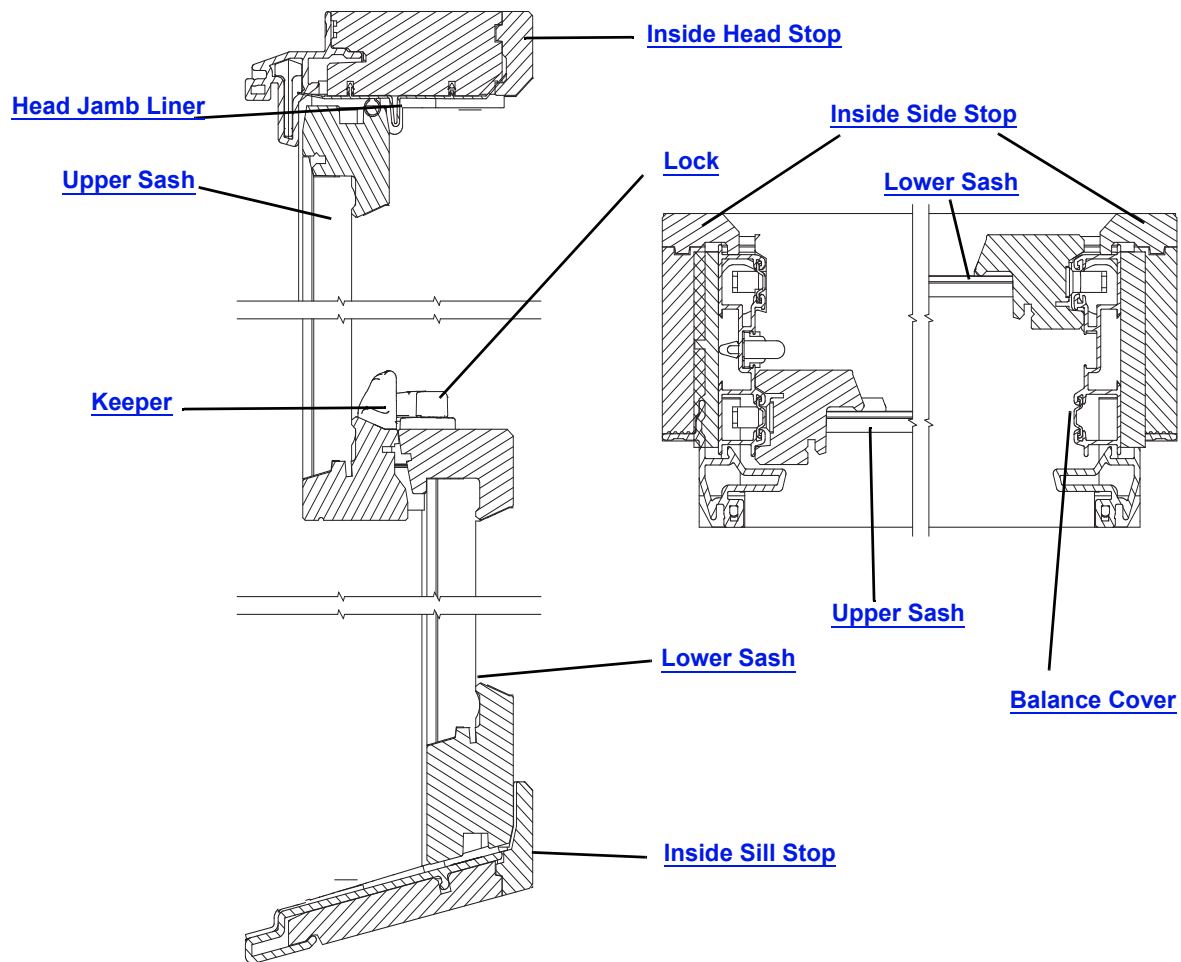

See latest [Product Details](#).

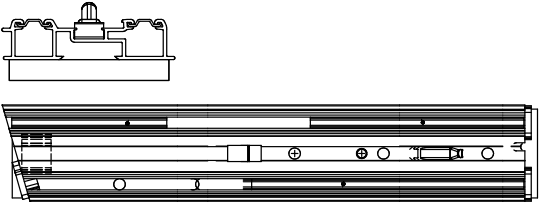

Tilt-Wash Frame Assembly

Frames



Jamb Liners	
Jamb Liner - Side	
 <p style="text-align: center;">Left-Hand</p>	<p>Note: Side jamb liners are made to order.</p> <p>Kit includes: Side jamb liner, balance covers (2), chimney plug, end plugs (3), support covers (2), wash assist stop, checkrail weatherstrip pad</p> <p><i>To order, state:</i></p> <ol style="list-style-type: none"> 1. Description of Part (side jamb liner, RH or LH) 2. Quantity 3. Color (gray or white) 4. Product ID (from product label, see page 5)

Jamb Liner - Head				
	<p>Note: Cut to size if necessary</p>	Length	Color	Order No.
		44 ³ / ₈	White	9044028
			Gray	9044033
Foam - Side Jamb Liner				
	<p>Note: Order by the foot.</p>			Order No.
				9067498

400 Series Tilt-Wash Insert Windows (2011 to Present)

Tilt-Wash Insert Windows

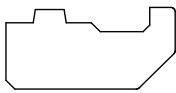
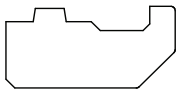
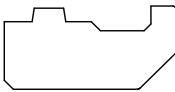
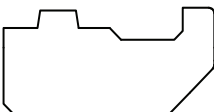
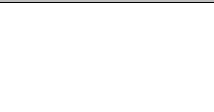
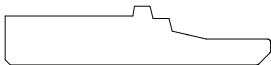
Frames

Stops	
Stop - Tilt Wash Insert Units / Head	
	<p>To order, state:</p> <ol style="list-style-type: none"> 1. Description of Part (head stop) 2. Quantity 3. Product ID (from product label, see page 5)
Stop - Tilt Wash Insert Units / Side	
	<p>To order state:</p> <ol style="list-style-type: none"> 1. Description of Part (side stop, RH or LH) 2. Quantity 3. Product ID (from product label, see page 5)
Stop - Picture and Transom Units / Head	
	<p>To order state:</p> <ol style="list-style-type: none"> 1. Description of Part (head stop) 2. Quantity 3. Product ID (from product label, see page 5)
Stop - Picture and Transom Units / Side	
	<p>To order state:</p> <ol style="list-style-type: none"> 1. Description of Part (side stop, RH or LH) 2. Quantity 3. Product ID (from product label, see page 5)
Stop - Picture and Transom Units / Sill	
	<p>To order state:</p> <ol style="list-style-type: none"> 1. Description of Part (sill stop) 2. Quantity 3. Product ID (from product label, see page 5)
Stop - Tilt Wash Insert Units / Sill / 0 Degree	
	<p>To order state:</p> <ol style="list-style-type: none"> 1. Description of Part ((sill stop, 0 degree) 2. Quantity 3. Product ID (from product label, see page 5)
Stop - Tilt Wash Insert Units / Sill / 8 Degree	
	<p>To order state:</p> <ol style="list-style-type: none"> 1. Description of Part ((sill stop, 8 degree) 2. Quantity 3. Product ID (from product label, see page 5)

Frames

Stop - Tilt Wash Insert Units / Sill / 14 Degree

	<p><i>To order state:</i></p> <ol style="list-style-type: none"> Description of Part (sill stop, 14 degree) Quantity Product ID (from product label, see page 5)
--	--

Glass Stop - Picture and Transom Units / Head

	<p><i>To order state:</i></p> <ol style="list-style-type: none"> Description of Part (glass stop head) Quantity Product ID (from product label, see page 5)
--	---

Glass Stop - Picture and Transom Units / Side

	<p><i>To order state:</i></p> <ol style="list-style-type: none"> Description of Part (glass side stop, RH or LH) Quantity Product ID (from product label, see page 5)
--	---

Glass Stop - Picture and Transom Units / Sill

	<p><i>To order state:</i></p> <ol style="list-style-type: none"> Description of Part (glass sill stop) Quantity Product ID (from product label, see page 5)
--	---

Filler





Filler - Picture and Transom Units

		Dimension	Finish	Order No.
		75"	Pine	0102712
			Oak	0102723
			Maple	0102724
			White	0102722

400 Series Tilt-Wash Insert Windows (2011 to Present)

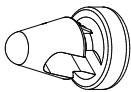
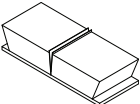
Tilt-Wash Insert Windows

Frames

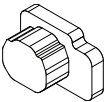
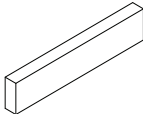
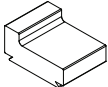
Frame Parts				
Wash Assist Stop				
				Order No. 1643028
Weatherstrip - Check Rail Liner				
				Order No. 9043854
Cover / Side Jamb Liner				
	Note: Replacement balancer covers to be cut in the field from lineal length sent.	Length	Color	Order No.
		44 1/16"	White	1650062
			Gray	2700135
Support Cover / Side Jamb Liner				
		Length	Color	Order No.
		4 5/8"	White	9043713
			Gray	9043714
End Plug - Head				
				Order No. 9043850
End Plug - Sill				
			Left	Right
			9045104	9045105
Sill Plug				
				Order No. 9043852
Chimney Plug				
				Order No. 9043851

Frames

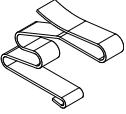
Balancer Clip		
		Order No.
		9045101

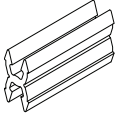
Glass Clip (Klick Fastener) - Picture and Transom Units		
		Order No.
		0102080

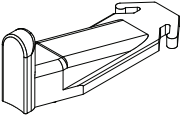
Wash Assist		
		Order No.
		1643027

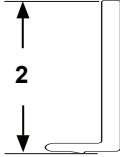
Exterior Trim Stop Cover				
Note: Exterior stop cover snaps into outside frame member creating a finished look between the insert window and the existing exterior window trim. Cut trim stop cover to desired width.				
	Length	Finish	Single Piece	
	12 ft	White	0112072	
		Terratone®	0112074	
		Sandtone	0112073	
		Forest Green	0112075	
		Canvas	9064537	
		Dark Bronze	9074456	
		Black	9131759	

400 Series Tilt-Wash Insert Windows (2011 to Present)

Tilt-Wash Insert Windows

Joining Components

Narrow Joining Parts

Trim Strip - Exterior Mull

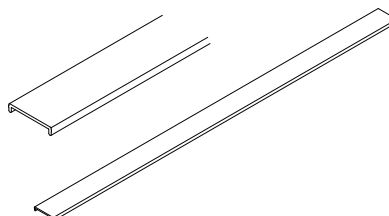

Color	4 ft	7 ft	12 ft
	Order No.	Order No.	Order No.
White	1292078	0112052	1292178
Terratone®	1292080	0112054	1292180
Sandtone	-	0112053	1292179
Forest Green	-	0112055	1292181
Canvas	9064538	9064536	9064539
Dark Bronze	9078217	9078216	9078218
Black	9138794	9138793	9067349

Inside Casing - Interior Mull

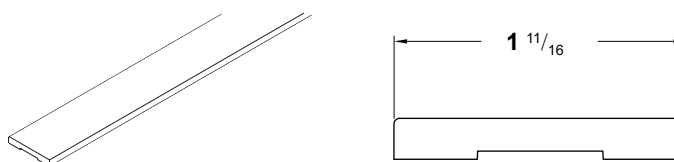

Finish	6 ft		8 ft	
	Single Piece	Package of 20	Single Piece	Package of 20
Pine	1611557	0112056	0112060	0112064
Maple	0102593	0112057	0102594	0112061
Oak	0102591	0112058	0102592	0112062
Prefinished White	0102595	0112059	0102596	0112063

Joining Hardware Kit

Kit includes: 2 joining brackets, 22 joining screws, and a joining installation guide	Order No. 0102022
---	-----------------------------

Joining Brackets (Pair)

Note: Brackets are included in joining hardware kit above.	Order No. 0112042
--	-----------------------------

Joining Screw

Note: #8 x 1 1/8" Sold individually. 22 screws are required per join. Screws are included in joining hardware kit above.	Order No. 0112077
--	-----------------------------

Installation Materials

Installation Materials

Installation Kit - Double-Hung Units

Note:

One kit is shipped with each double-hung insert window.

Order No.

9045106

Kit includes: Installation screws, 40 installation shims (1/16" thick, quantity 32; 1/32" thick, quantity 8), 3/8" diameter backer rod, and hole plugs

Installation Kit - Picture and Transom Units

Note:

One kit is shipped with each picture or transom insert window.

Order No.

0102021

Kit includes: Installation screws, 56 installation shims (1/16" thick, quantity 40; 1/32" thick, quantity 16), 3/8" diameter backer rod

Hole Plug

Note:

Quantity of 6.

Color

Order No.

Gray

9044914

White

9045102

Installation Shim Insert

Case of 2000

1/16"

1/32"

0112081

0112082

Installation Screw - Double-Hung Units

Note: #8 x 2" panhead

Used to attach insert frame to existing opening.

Order No.

0112047

Exterior Trim Stop Cover

Note:

Exterior stop cover snaps into outside frame member creating a finished look between the insert window and the existing exterior window trim. Available as single pieces or a package of 20. Cut trim stop cover to desired width.

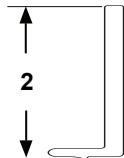

Length

12 ft

Finish

Single Piece

Package of 20

White

0112072

Terratone®

0112074

Sandtone

0112073

Forest Green

0112075

Canvas

9064537

Dark Bronze

9074456

Black

9131759

400 Series Tilt-Wash Insert Windows (2011 to Present)

Tilt-Wash Insert Windows

Installation Materials

Stops - Interior

Note:

The interior stop can be ripped to desired width. Rip down center of part to obtain two stops approximately 1-1/4" wide. Interior stop profile is reversible after ripping. Use the milled profile to complement Tilt-Wash insert window sash profile or use reverse side with square edge to trim interior of window.

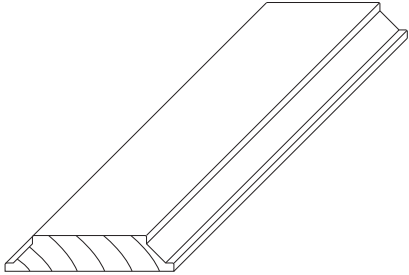

Dimensions (w x l)	Finish	Single
2 21/32 x 48	Pine	0112021
	Maple	0112022
	Oak	0112023
	Prefinished White	0112024
2 21/32 x 84	Pine	0112025
	Maple	0112026
	Oak	0112027
	Prefinished White	0112028

Notes

400 Series Tilt-Wash Insert Windows (2011 to Present)

Service Replacement

Service Replacement Only

Service Replacement Only Parts

Note:

This section is specifically designed for parts that should only be ordered if a Territory Service Manager/Service Provider Company has requested them to be ordered or if the customer agrees to also pay for a non-warranty repair/replace service job (subject to availability) for these parts to be installed. We do not recommend anyone other than a trained AW employee or Service Provider install these parts due to the complexity of installation, modifications required for installation and/or requirement of special tools.

Complete Frame

Complete Frame

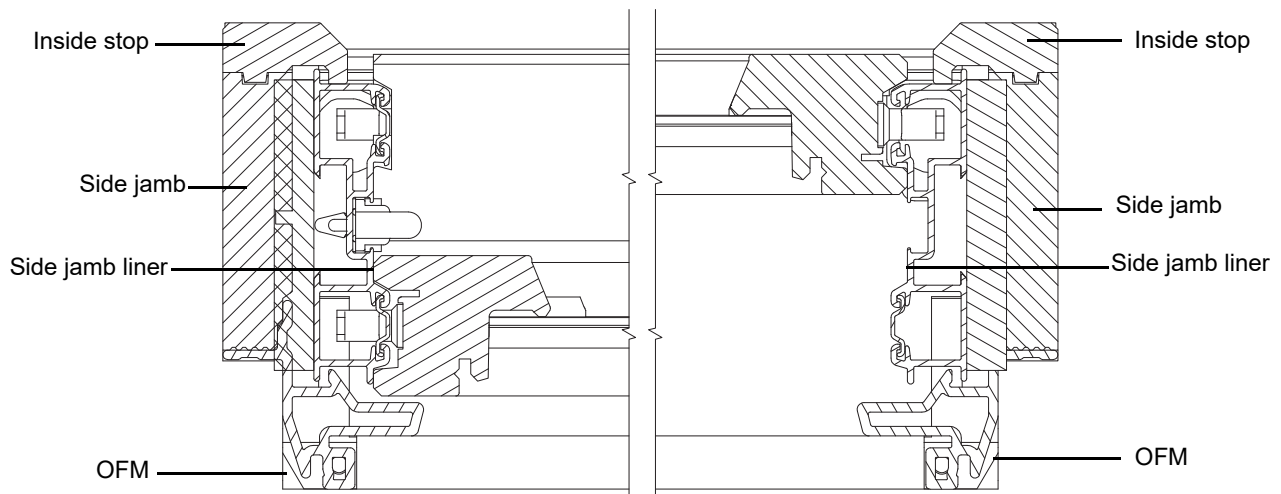

Note:

Replacement frames are made to order.

Frame includes assembled wood jambs with OFM, side jamb liners, head liner, and inside stops. Balancers included if referenced in description. Frame does not include L-trim

To order, state:

1. Description of part (Complete Frame with balancers or Complete Frame without balancers)
2. Quantity
3. Product ID (from product label, see [page 5](#))

Service Replacement Only

Glazing Bead

Glazing Bead - Standard / Upper Sash

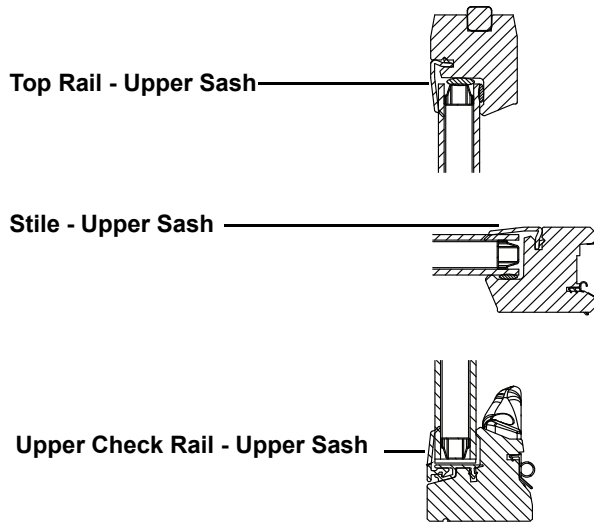

To order state:

1. Description of Part (glazing bead type):
 Top Rail - Upper Sash
 Stile - Upper Sash
 Upper Check Rail - Upper Sash
2. Quantity
3. Product ID (from product label, see [page 5](#))

Glazing Bead - Standard / Lower Sash

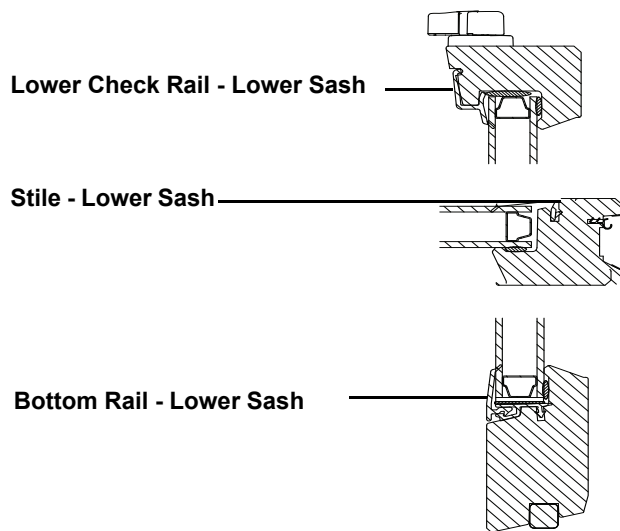

To order state:

1. Description of Part (glazing bead type):
 Lower Check Rail- Lower Sash
 Stile - Lower Sash
 Bottom Rail - Lower Sash
2. Quantity
3. Product ID (from product label, see [page 5](#))

400 Series Tilt-Wash Insert Windows (2011 to Present)

Service Replacement

Service Replacement Only

Glazing Bead - High Definition / Upper Sash

Top Rail - Upper Sash

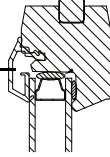

Stile - Upper Sash

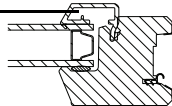

Upper Check Rail - Upper Sash

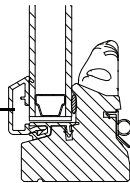

To order state:

1. Description of Part (glazing bead type):
Top Rail - Upper Sash
Stile - Upper Sash
Upper Check Rail - Upper Sash
2. Quantity
3. Product ID (from product label, see [page 5](#))

Glazing Bead - High Definition / Lower Sash

Lower Check Rail - Lower Sash

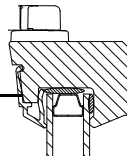

Stile - Lower Sash

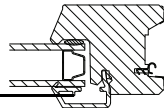

Bottom Rail - Lower Sash

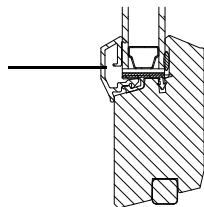

To order state:

1. Description of Part (glazing bead type):
Lower Check Rail - Lower Sash
Stile - Lower Sash
Bottom rail - Lower Sash
2. Quantity
3. Product ID (from product label, see [page 5](#))

Service Replacement Only

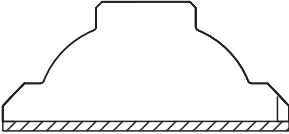
Exterior Grilles - HDN									
Exterior Grille - HDN / Lineal / PVC									
									
Length	White			Terratone®			Sandtone		
	3/4"	7/8"	1 1/8"	3/4"	7/8"	1 1/8"	3/4"	7/8"	1 1/8"
60 in	2322030	2322034	2322038	N/A	N/A	N/A	N/A	N/A	N/A
84 in	2322031	2322035	2322039	N/A	N/A	N/A	N/A	N/A	N/A