

NARROLINE® GLIDING PATIO DOORS

Three Patio Door Heights

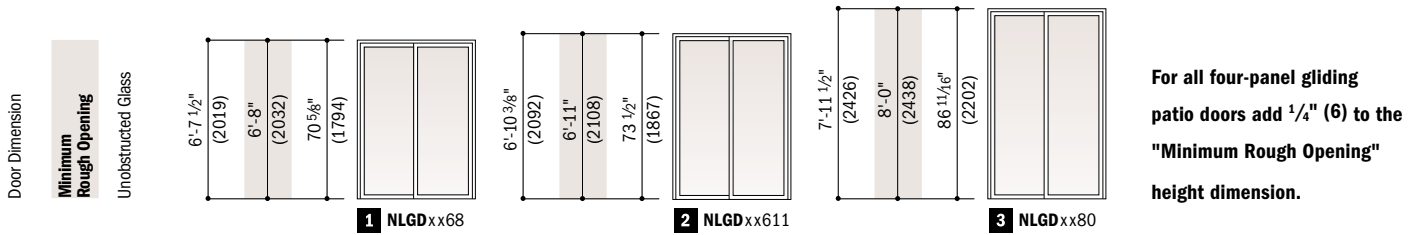

Table of Narroline® Gliding Patio Door Sizes

Scale 1/8" = 1'-0" (1:96)

Door Dimension	2'-8"	4'-11 1/4"	4'-11 1/4"	9'-9"
	(813)	(1505)	(1505)	(2972)
Minimum Rough Opening	2'-8 3/4"	5'-0"	5'-0"	9'-9 3/4"
	(832)	(1524)	(1524)	(2991)
Unobstructed Glass (single panel only)	24 1/2"	24 1/2"	24 1/2"	24 1/2"
	(622)	(622)	(622)	(622)



Custom-size doors are available in 1/8" (3) increments between the smallest and largest standard door sizes. **Measurement guide** can be found at andersenwindows.com/measure. Some restrictions apply. Contact your Andersen supplier for availability.

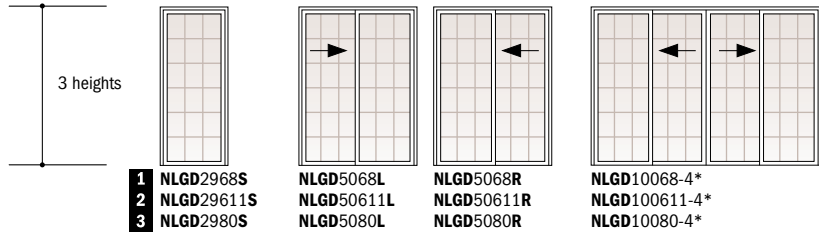

Door Dimension	3'-2"	5'-11 1/4"	5'-11 1/4"	11'-9"
	(965)	(1810)	(1810)	(3581)
Minimum Rough Opening	3'-2 3/4"	6'-0"	6'-0"	11'-9 3/4"
	(984)	(1829)	(1829)	(3600)
Unobstructed Glass (single panel only)	30 1/2"	30 1/2"	30 1/2"	30 1/2"
	(775)	(775)	(775)	(775)

Viewed from the exterior. Arrow indicates direction of panel operation.

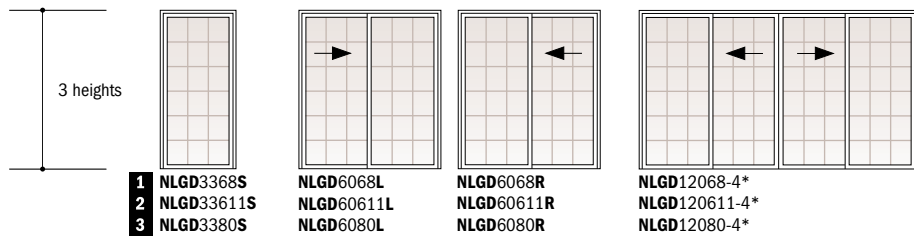

Stationary (S) doors can be used as an individual unit or as a sidelight.

Door Dimension	4'-2"	7'-11 1/4"	7'-11 1/4"	15'-9"
	(1270)	(2419)	(2419)	(4801)
Minimum Rough Opening	4'-2 3/4"	8'-0"	8'-0"	15'-9 3/4"
	(1289)	(2438)	(2438)	(4820)
Unobstructed Glass (single panel only)	42 1/2"	42 1/2"	42 1/2"	42 1/2"
	(1080)	(1080)	(1080)	(1080)

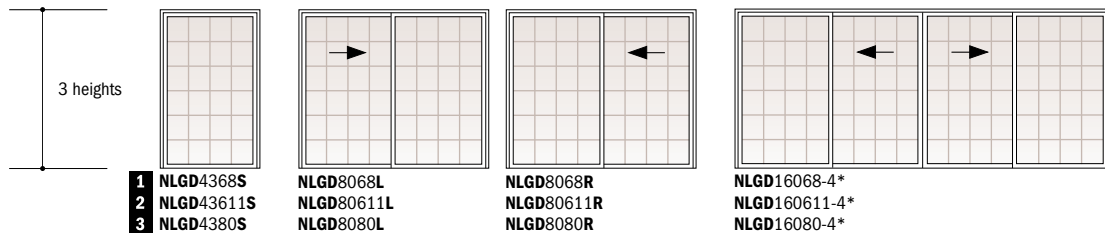

*"Window Dimension" always refers to outside frame to frame dimension.
 * "Minimum Rough Opening" dimensions may need to be increased to allow for use of building wraps, flashing, sill panning, brackets, fasteners or other items.
 * Dimensions in parentheses are in millimeters.
 *Add 1/4" (6) to the "Minimum Rough Opening" height dimension for four-panel doors.

Custom Patio Door Size Range



Available in 1/8" (3) increments between minimum and maximum widths and heights.

Some restrictions apply, contact your Andersen supplier. **Measurement guide** for custom sized patio doors can be found at andersenwindows.com/measure.

Single Stationary Panel

ANDERSEN® 400 SERIES FRENCHWOOD® GLIDING PATIO DOORS

ANDERSEN 200 SERIES NARROLINE® & PERMA-SHIELD® GLIDING PATIO DOORS

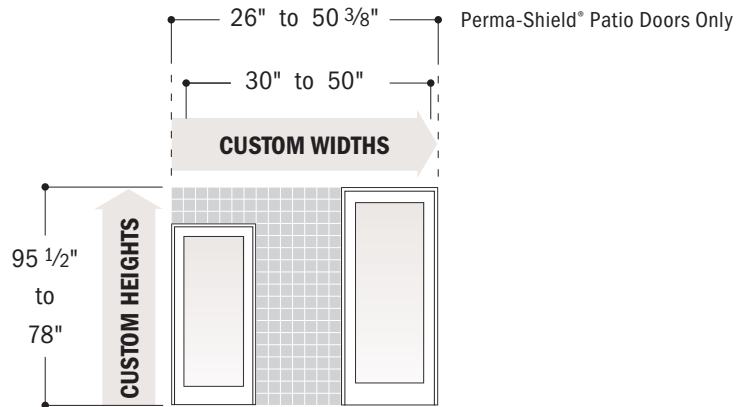

2-Panel

ANDERSEN 400 SERIES FRENCHWOOD GLIDING PATIO DOORS

ANDERSEN 200 SERIES NARROLINE & PERMA-SHIELD GLIDING PATIO DOORS

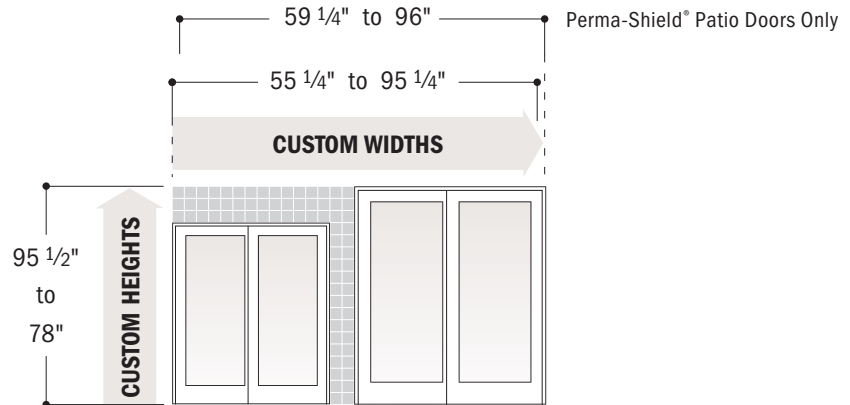

4-Panel

ANDERSEN 400 SERIES FRENCHWOOD GLIDING PATIO DOORS

ANDERSEN 200 SERIES NARROLINE GLIDING PATIO DOORS

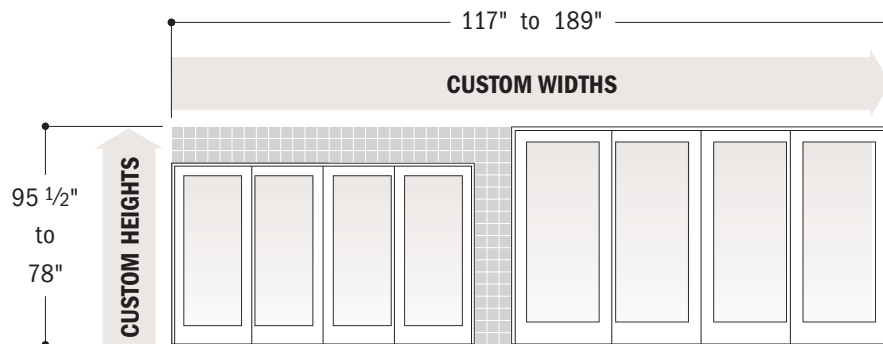

- "Door Dimension" always refers to outside frame to frame dimension.
- Dimensions in parentheses are in millimeters.